

Article number: 604146021037

Description: Timing belt pulley with hub
21 XL 037

Measures

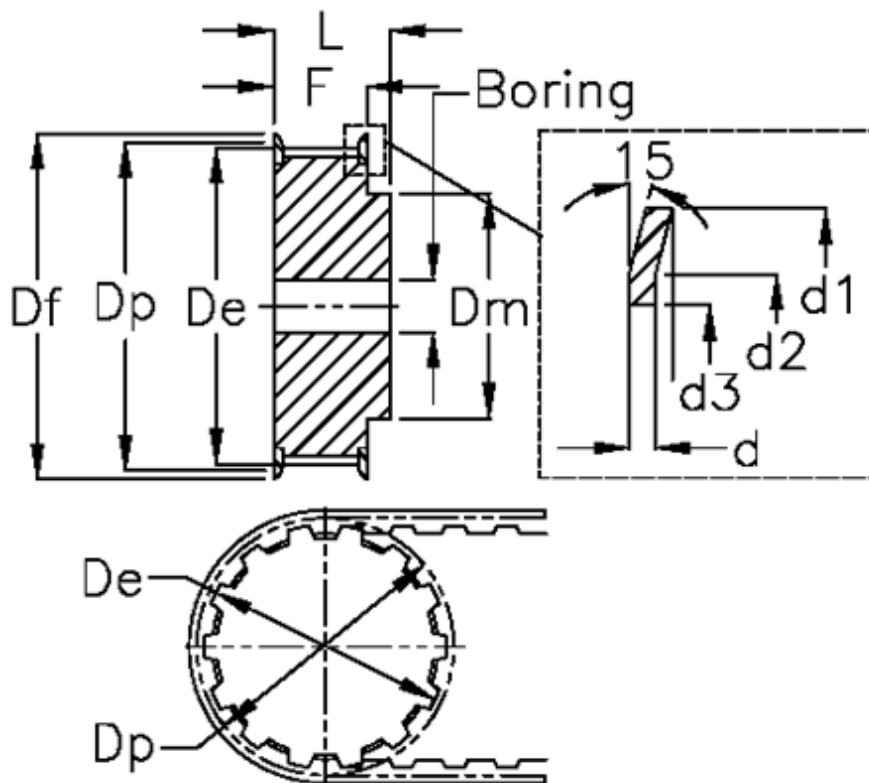

d = 1	F = 14.3	Width = XL 037
d1 = 38	Flange type = F14	
d2 = 34	L = 22.2	
d3 = 26.5	Max bore = 17.5	
De = 33.45	Pitch = 1/5"	
Df = 38	Pre-drilled = 6	
Dm = 23.8	Tooth number = 21	
Dp = 33.96	Weight = 0.09	